

BMP522.SXD/AdB/HT

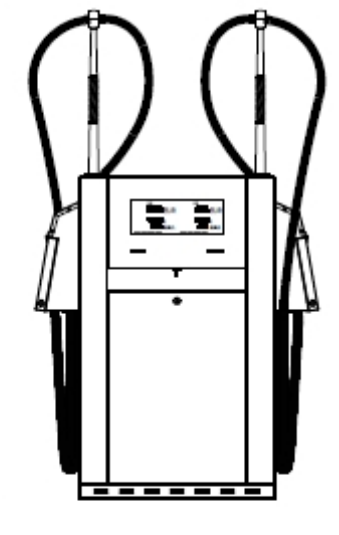

BMP522.SXD/AdB/HT-HS

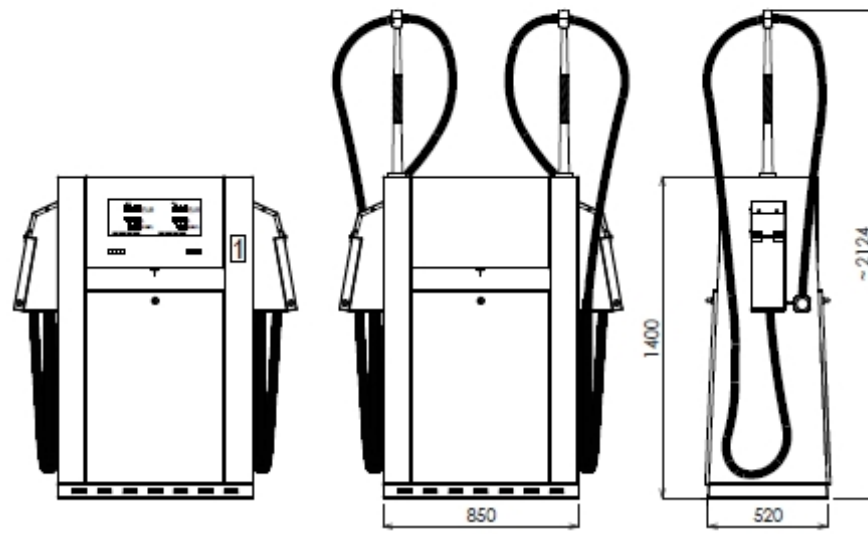
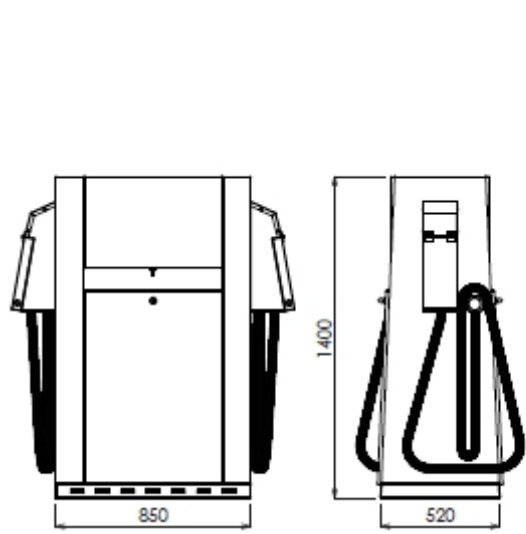

BMP522.SXL/AdB/HT

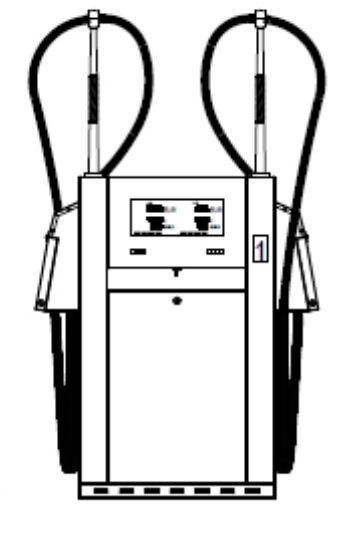

BMP522.SXL/AdB/HT-HS

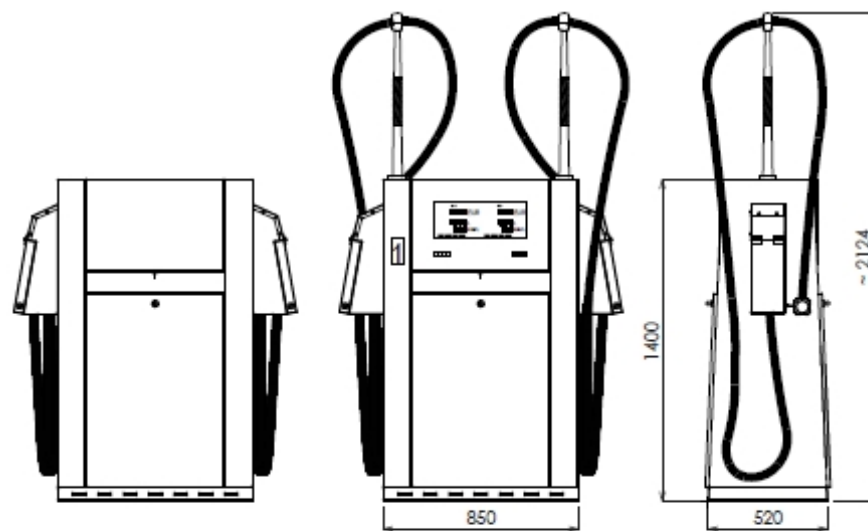
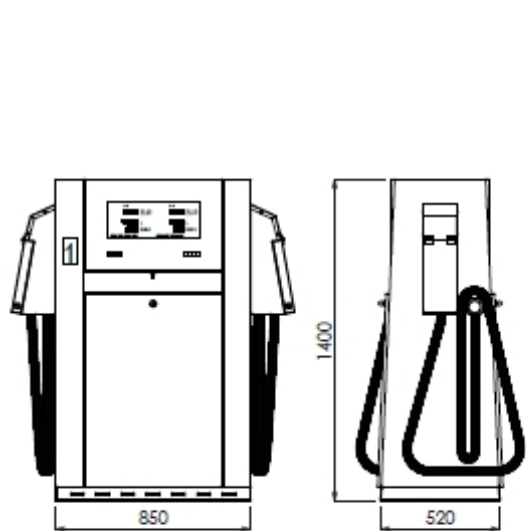

BMP522.SXR/AdB/HT

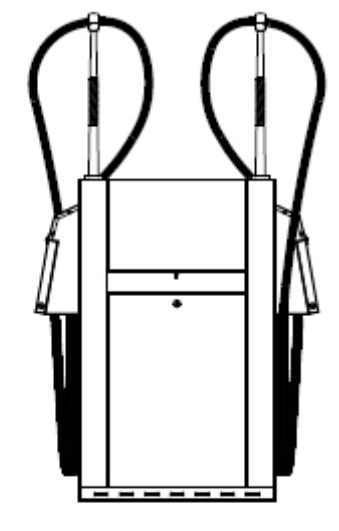

BMP522.SXR/AdB/HT-HS

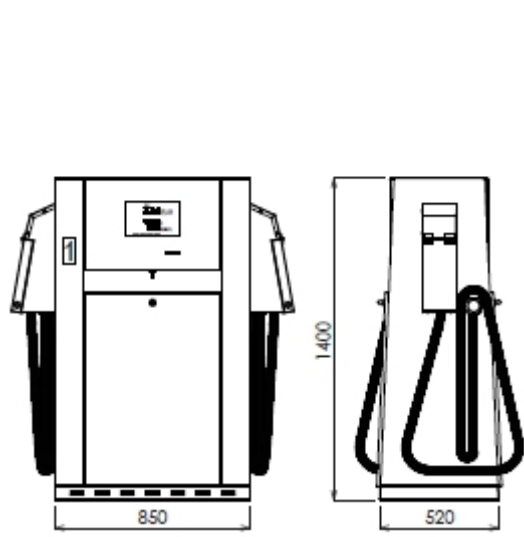

BMP512.SXD/AdB/HT-NC

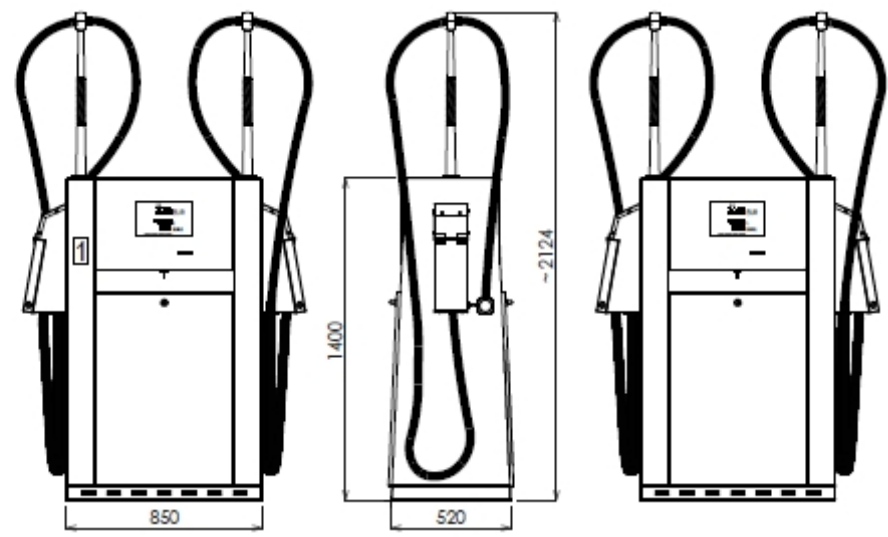

BMP512.SXD/AdB/HT-NC -HS

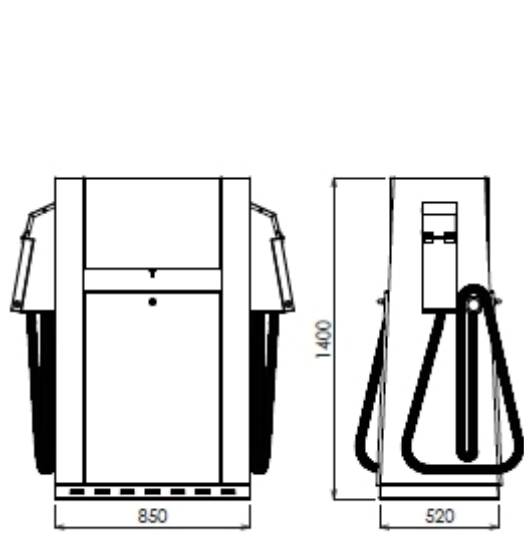

BMP512.SXL/AdB/HT-NC

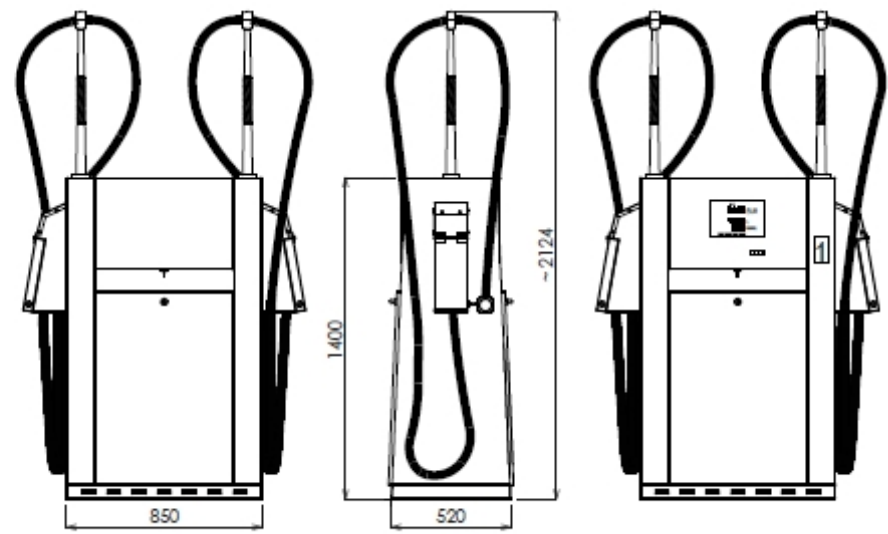

BMP512.SXL/AdB/HT-NC -HS

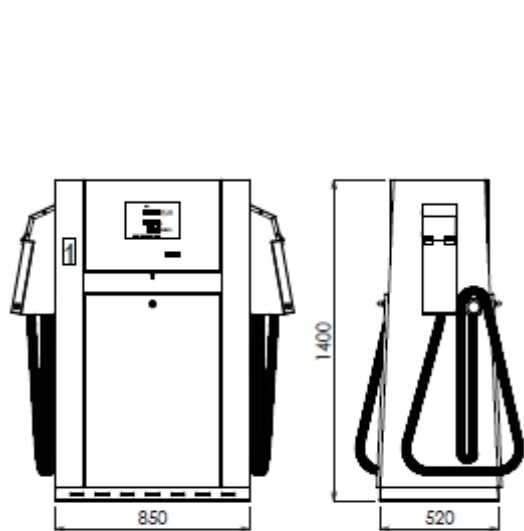

BMP512.SXR/AdB/HT-NC

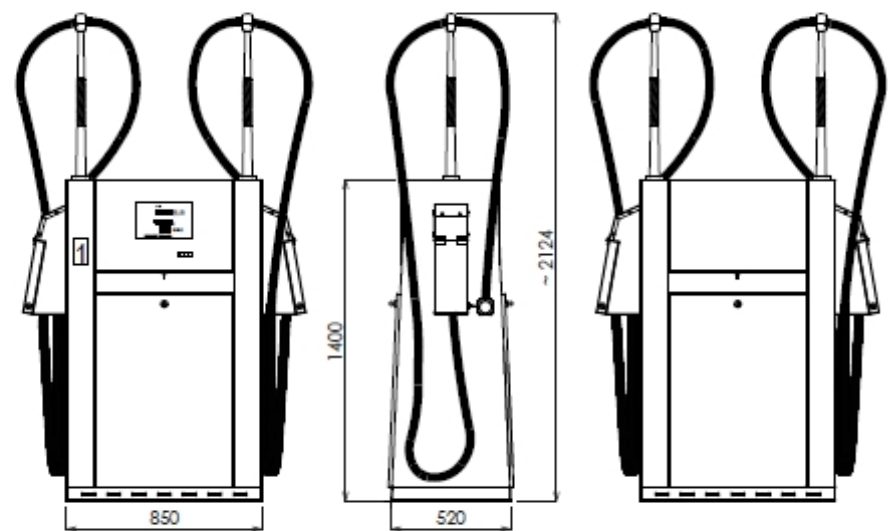

BMP512.SXR/AdB/HT-NC -HS

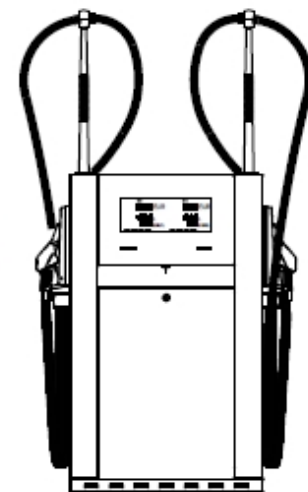
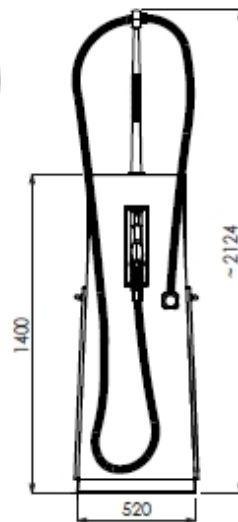
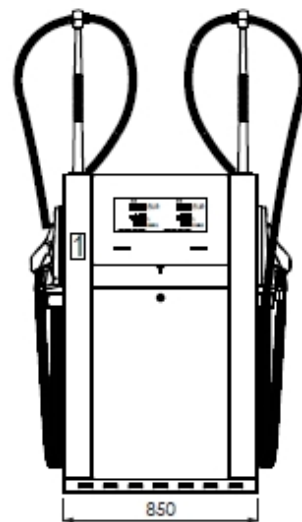
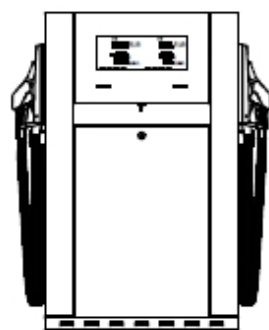
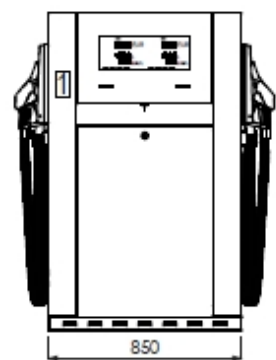

BMP522.SXD/AdB

BMP522.SXD/AdB-HS

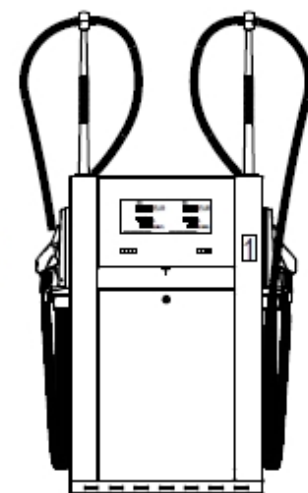
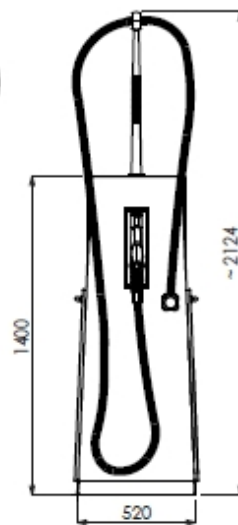
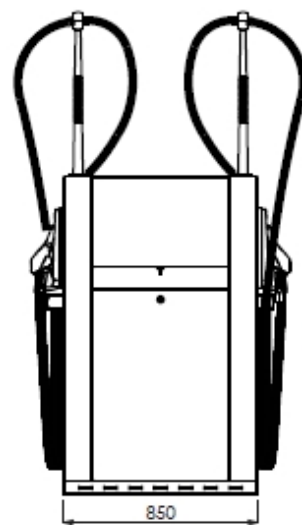
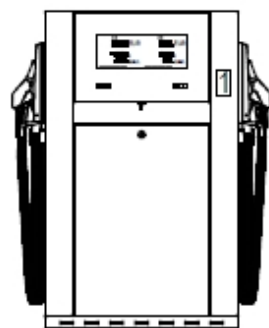
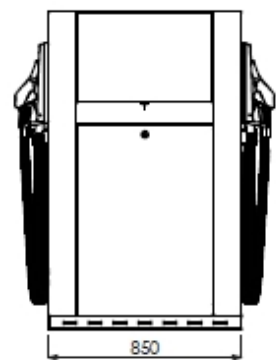

BMP522.SXL/AdB

BMP522.SXL/AdB-HS

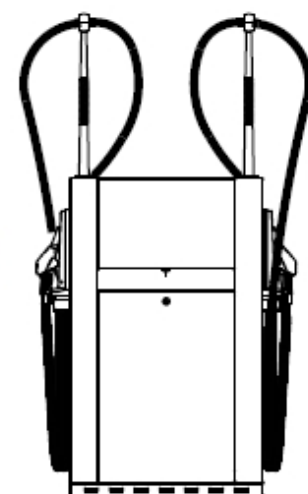
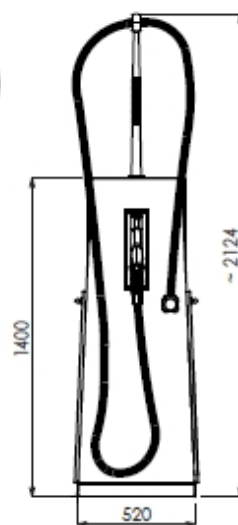
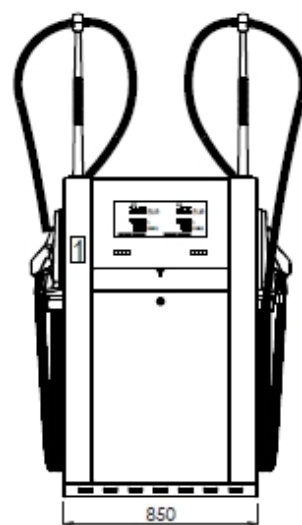
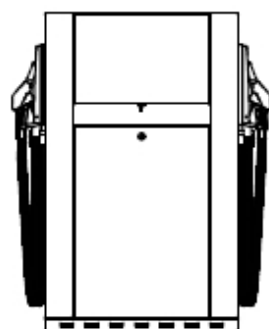
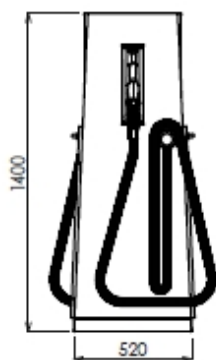
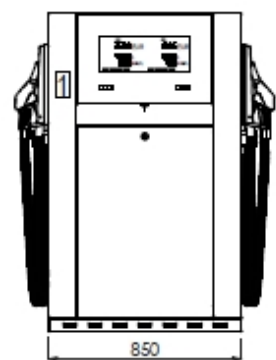

BMP522.SXR/AdB

BMP522.SXR/AdB-HS

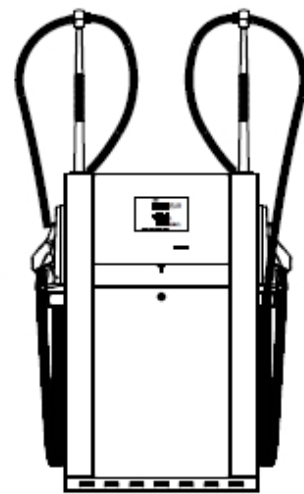
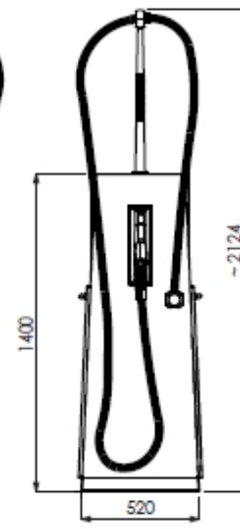
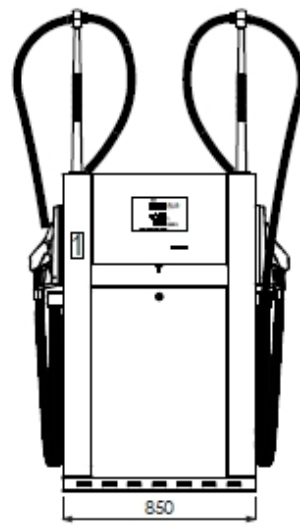
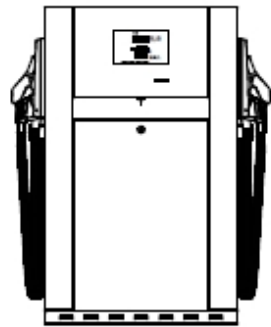
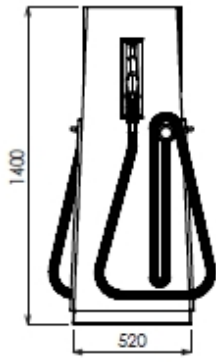
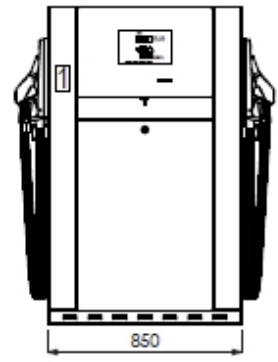

BMP512.SXD/AdB-NC

BMP512.SXD/AdB-NC -HS

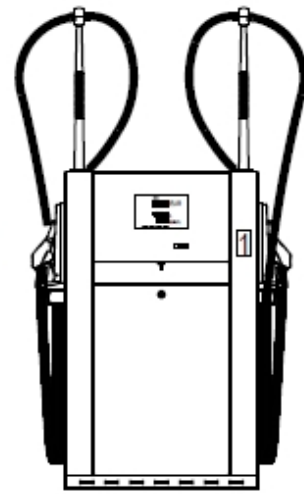
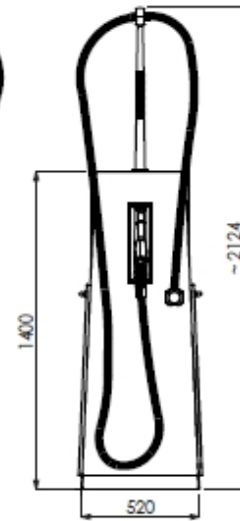
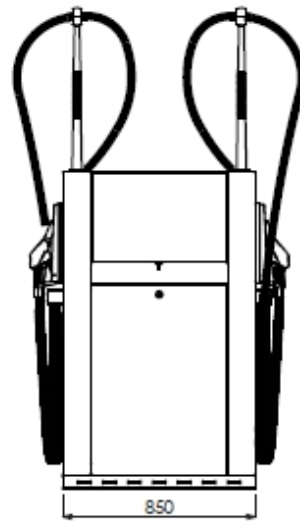
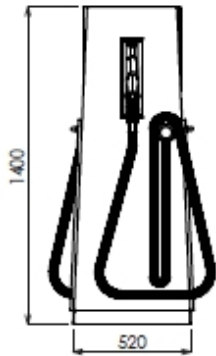
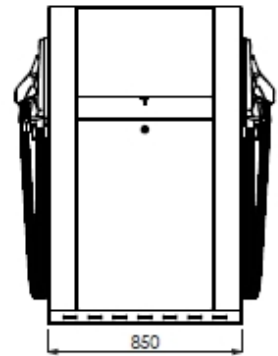

BMP512.SXL/AdB-NC

BMP512.SXL/AdB-NC -HS

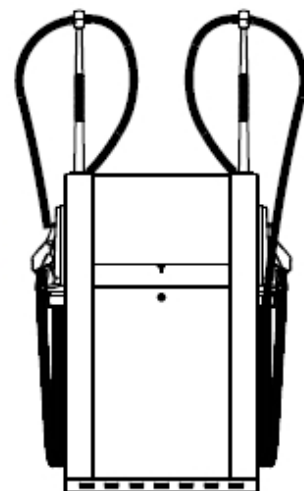
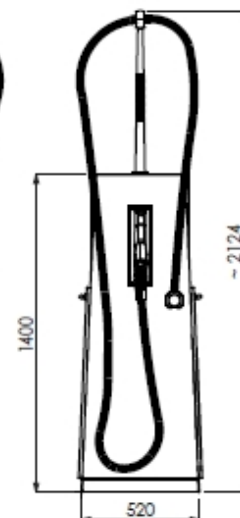
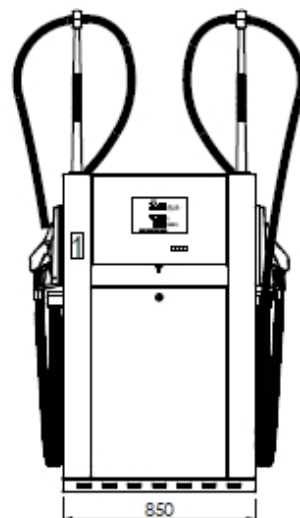
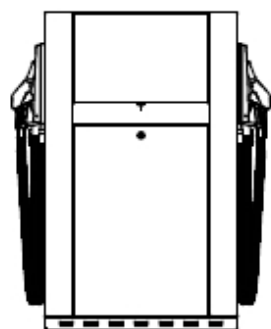
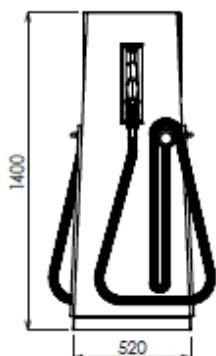

BMP512.SXR/AdB-NC

BMP512.SXR/AdB-NC -HS